

# Flat Panel VMT

Installation Manual

EN

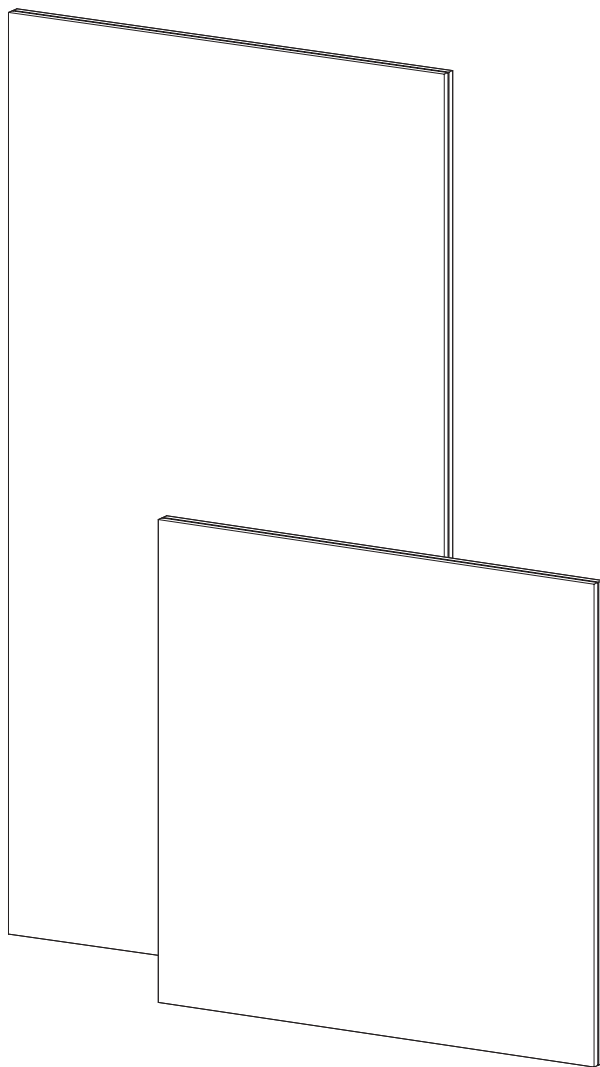

**V/COUSTIC**

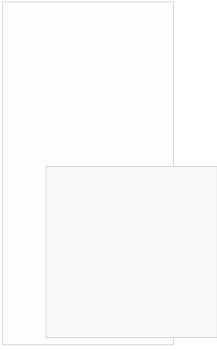
MATERIAL NEEDED**Included**

Flat Panel VMT x8



Velcro Stripes x16

**Not Included**

Level



Measuring Tape



Box Cutter

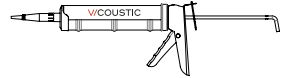

Flexi Glue Ultra

## Available formats

1190x595mm



595x595mm

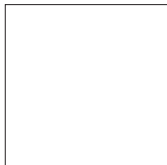

## Partial wall installation

You can also use this method to install this product on the ceiling.

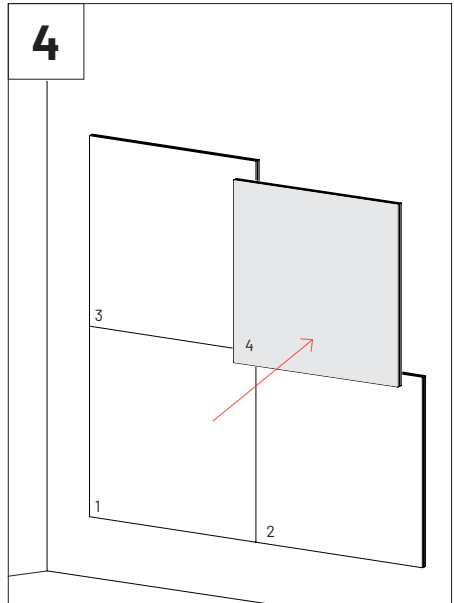
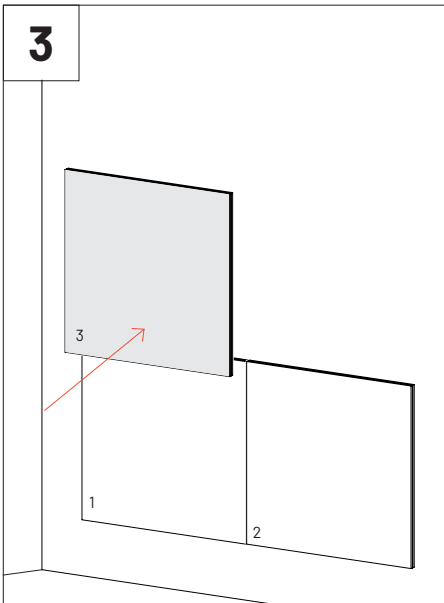
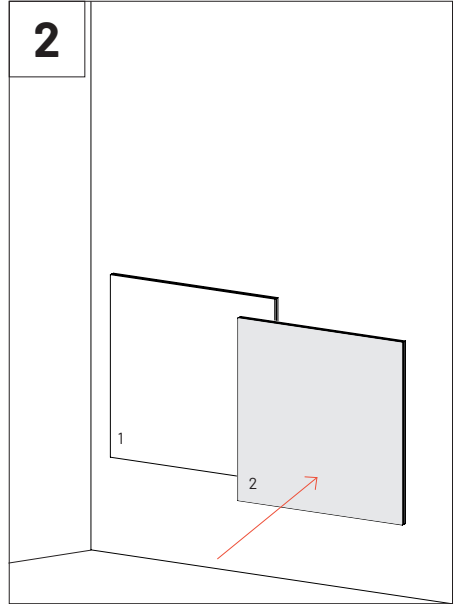
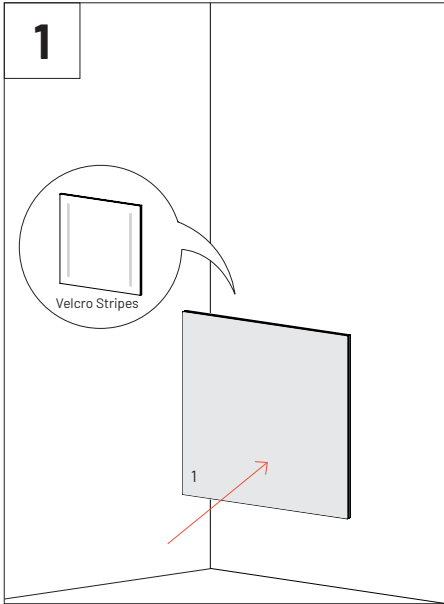

## Full wall installation

\*You can also use this method to install this product on the ceiling.

**1**

Measure wall height in both sides. Take the smallest height.

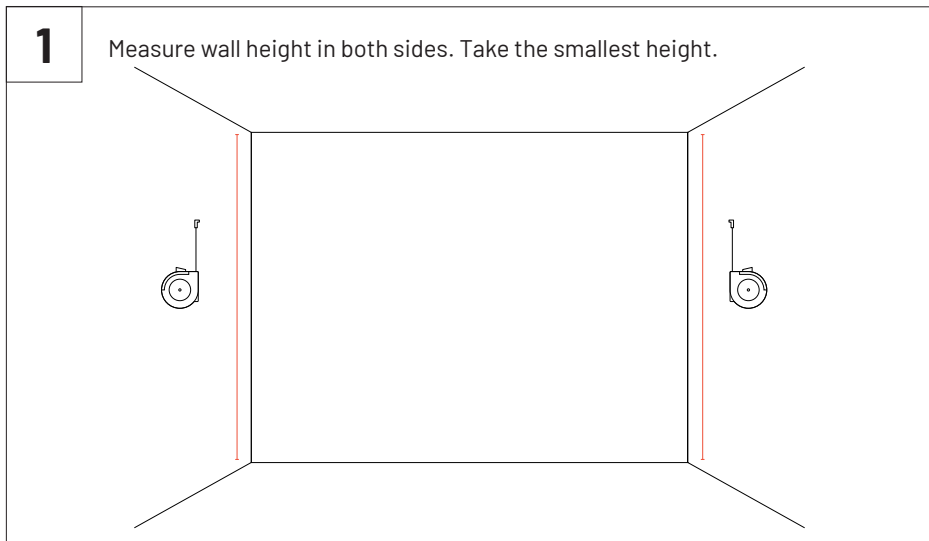
**2**

Based on the smallest height, calculate if it is necessary to cut one of the panels to fill the entire wall height. Check for continuity between panels before cutting.

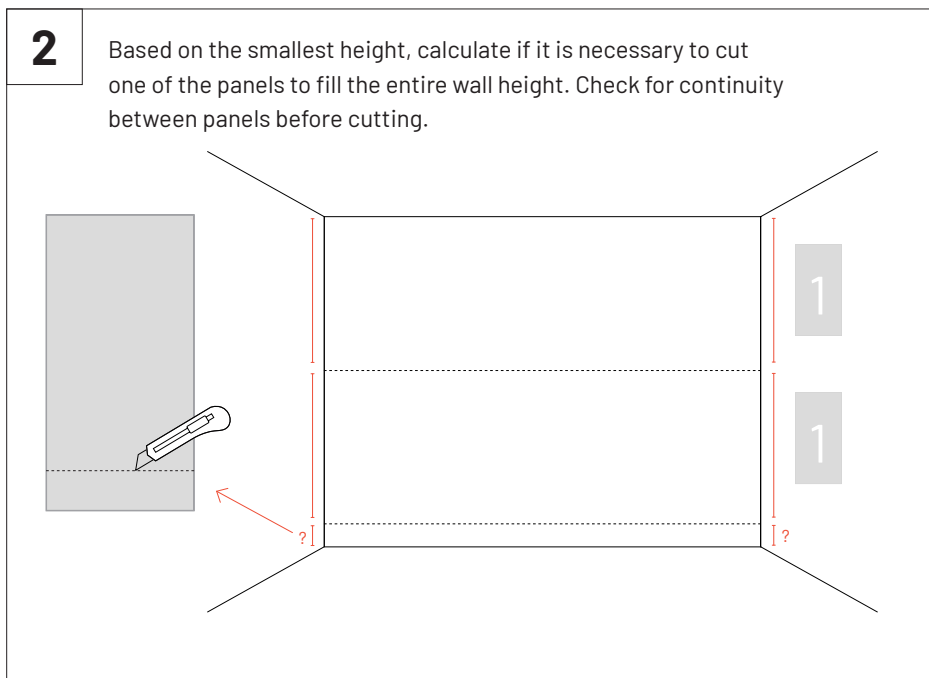

3

Glue the Velcro tape in the wall. It is recommended to use 2 stripes of Velcro per panel (included). You can also glue the panels directly to the wall with Flexi Glue Ultra

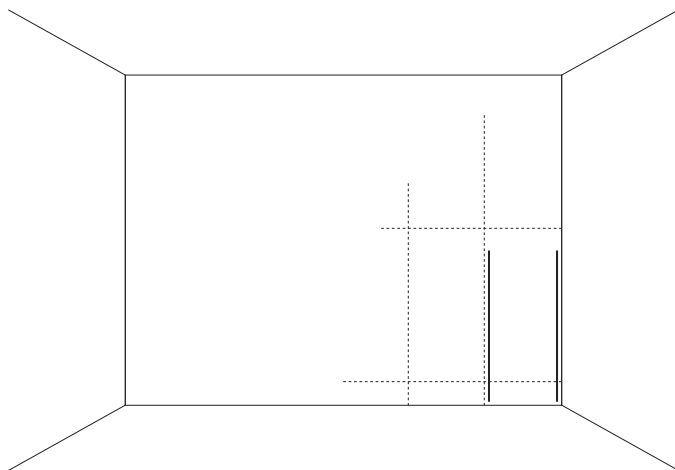

4

Start the installation from the bottom-right side (If cuted panels are going to be used it is recommended to start with these). Check if panels are leveled before proceeding to next row.

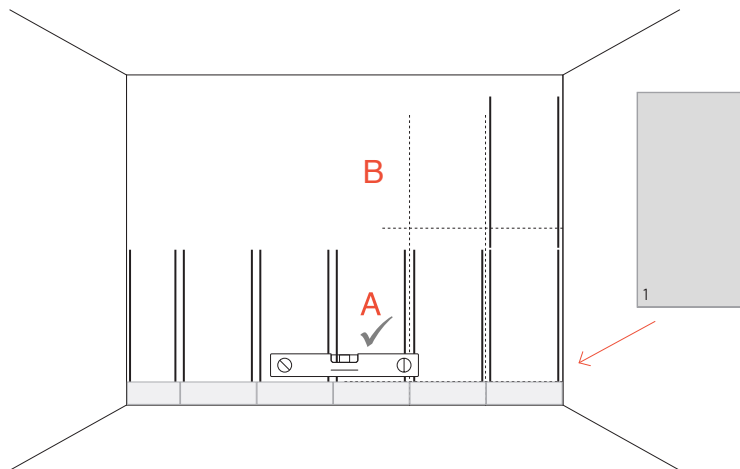

**5**

Install the remaining panels.

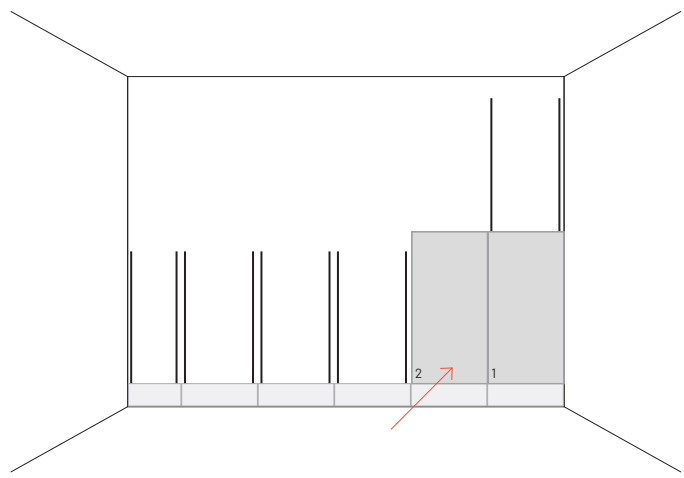

**6**

VMT boards can be installed vertically or horizontally, depending on the pattern and desired orientation.

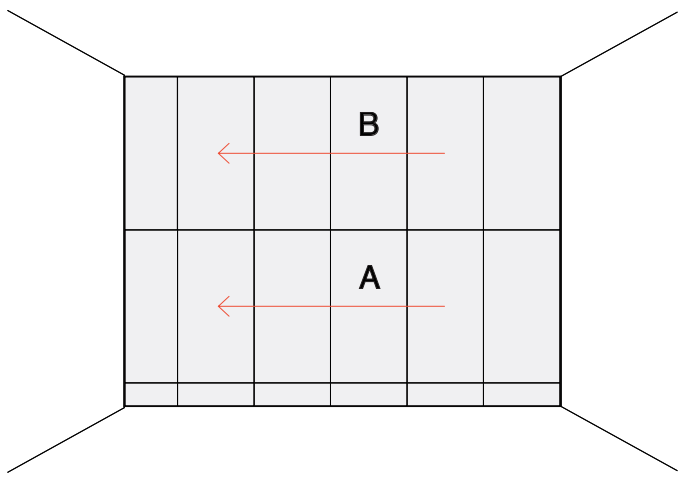



### **Main Office, R&D & Logistics**

Avenida do Pólo 3, N.º 159, Carvalhosa  
4590-137 Paços de Ferreira, Portugal  
T (+351) 255 136 746

### **Office**

Rua Quinta do Bom Retiro N.º 16, Armazém 9  
2820-690 Charneca da Caparica, Portugal  
T (+351) 212 964 100

### **Info and Sales**

E [sales@vicoustic.com](mailto:sales@vicoustic.com)

[www.vicoustic.com](http://www.vicoustic.com)



© Vicoustic, 2019 | V3

No parts of this document might be copied and/or published without written consent of Vicoustic.